

Modeling analysis of the Tracking Aerosol Convection Experiment Air Quality (TRACER-AQ) and over-water measurements to improve prediction of on-land and offshore ozone

Yuxuan Wang, James Flynn, Xueying Liu, Wei Li, Claudia Bernier, Shailaja Wasti, Evelyn Martinez, Geoff Roberts, Yongcheol Jeong

Dept. Earth and Atmospheric Sciences, University of Houston

Paul Walter

Institute for Interdisciplinary Science, St. Edward's University

Acknowledgment: This research presentation was supported by funding from the Texas Commission on Environmental Quality (TCEQ). The findings, opinions, or conclusions expressed do not necessarily represent those of the TCEQ.

TRACER-AQ1 Intensive Operational Period: September 2021

3-D Photochemical Model

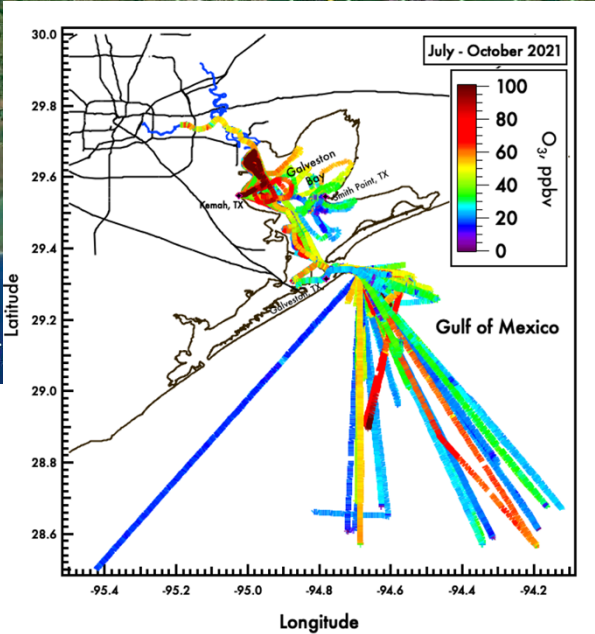
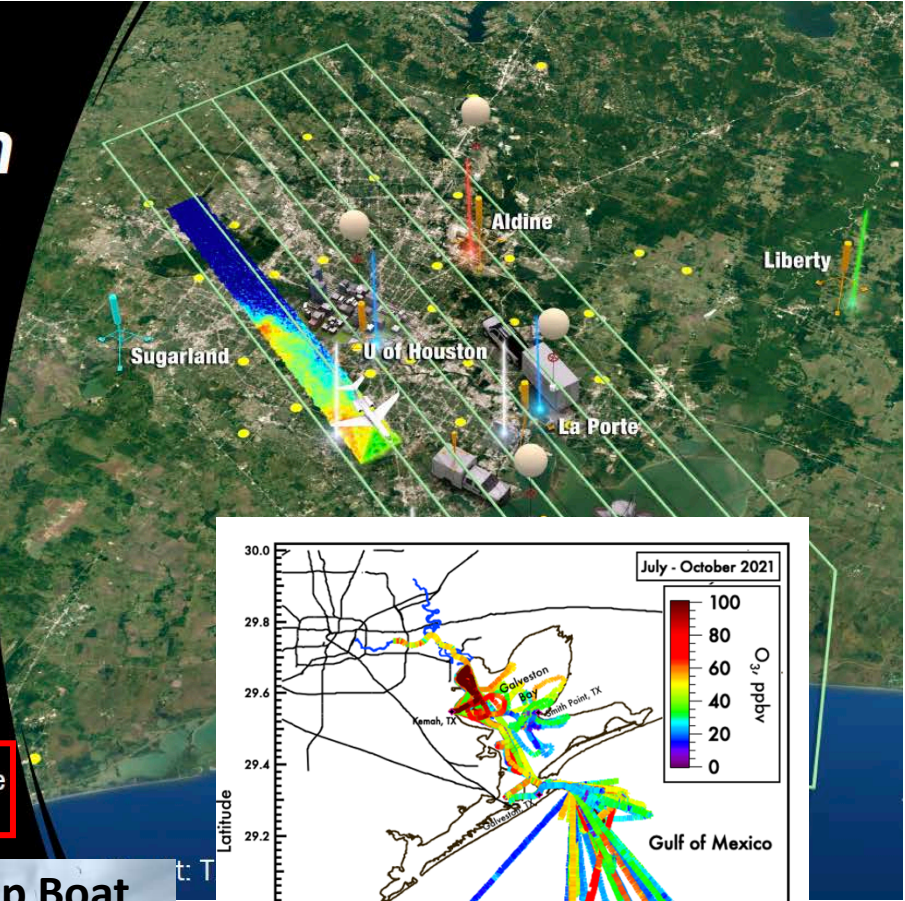
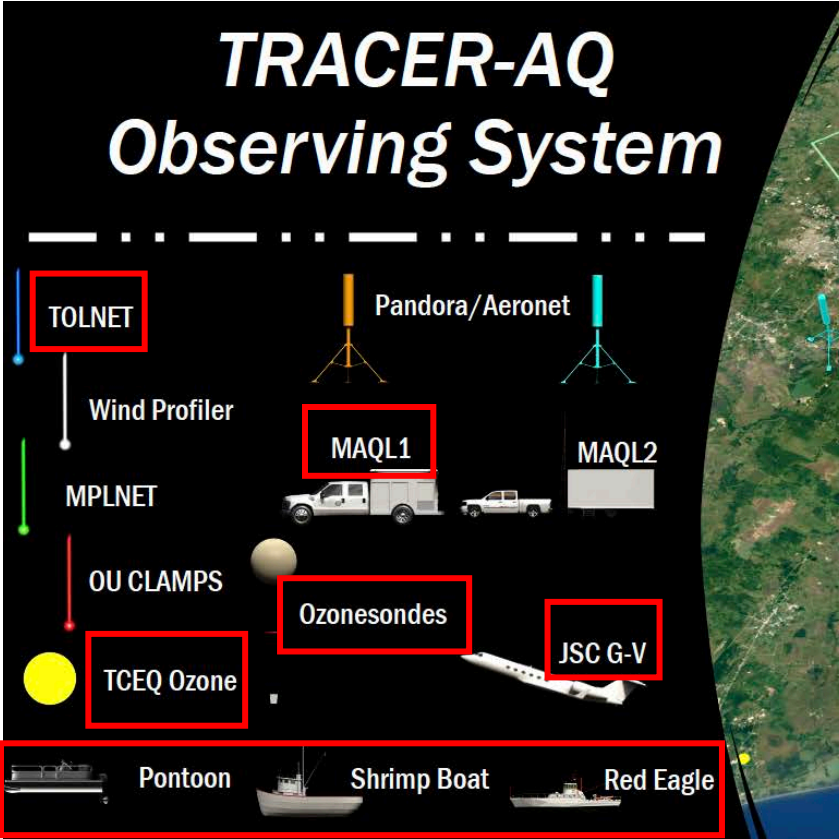
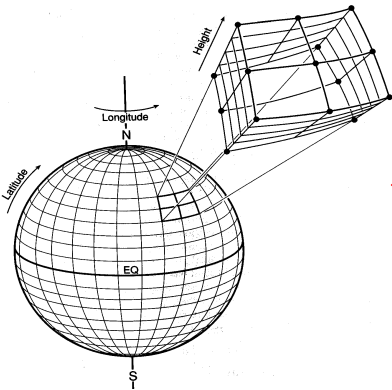

Griggs et al., 2023

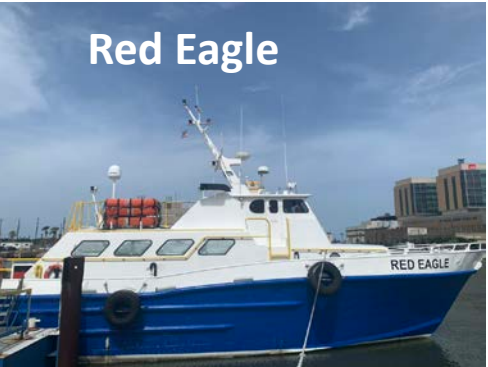

Objectives

1. Which **configurations and simulation settings of WRF** most accurately replicate the extensive meteorological data collected as part of TRACER-AQ?
2. How well do coupled mesoscale meteorological and photochemical grid modeling of **coastal/maritime boundary layers** replicate observations?
3. How well do **photochemical grid models predict over-water ozone** concentrations and formation rates?
4. What are the **spatial distributions of ozone and ozone precursors** during TRACER-AQ on days with on-land monitors recording exceedances of the NAAQS and how well does the photochemical model predict such distributions?
5. Which **emission source categories** affect ozone formation over Galveston Bay and the Gulf of Mexico?

WRF-driven Photochemical Models: CAMx, WRF-GC, WRF-Chem

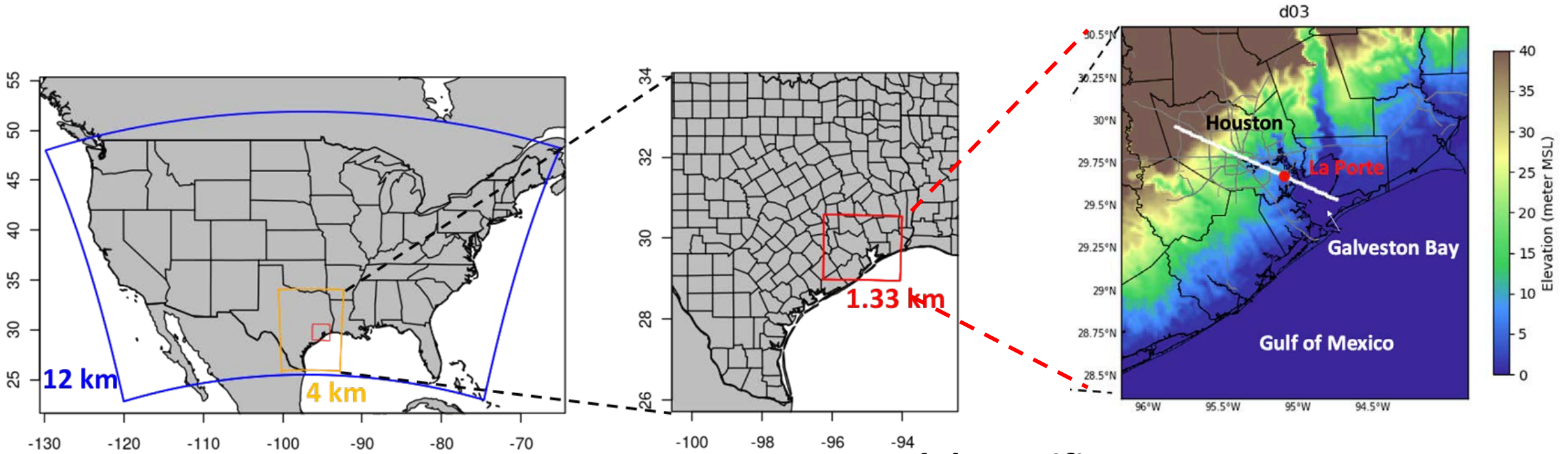

Model Specifics

- (1) WRF v3.9.1.1; CAMx v7.10; WRF-GC v2.0; WRF-Chem v4.2.2
- (2) WRF-GC and CAMx use boundary conditions from GEOS-Chem; WRF-Chem from WACCM
- (3) Anthropogenic emissions: SIP 2019 Emissions in Texas, regridded from 4 km to 1.33 km in D03 domain
- (4) Natural and fire emissions differ by model

	Region	Horizontal Resolution
Domain 1	CONUS	12 km × 12 km
Domain 2	Southeast Texas	4 km × 4 km
Domain 3	Greater Houston	1.33 km × 1.33 km

Three Ozone Episodes: Sep 6-11, 17-19, and 23-26

Ozone (ppbv)

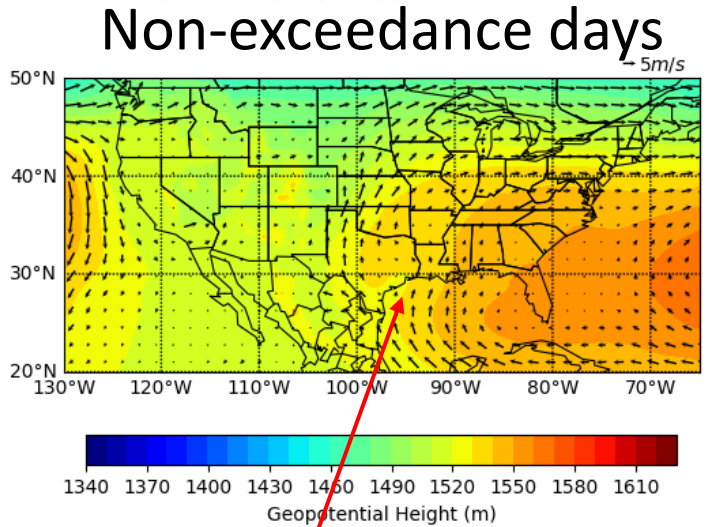
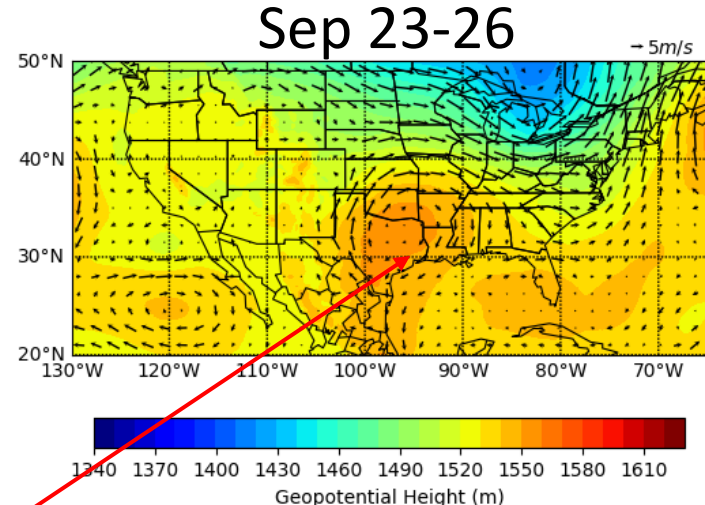
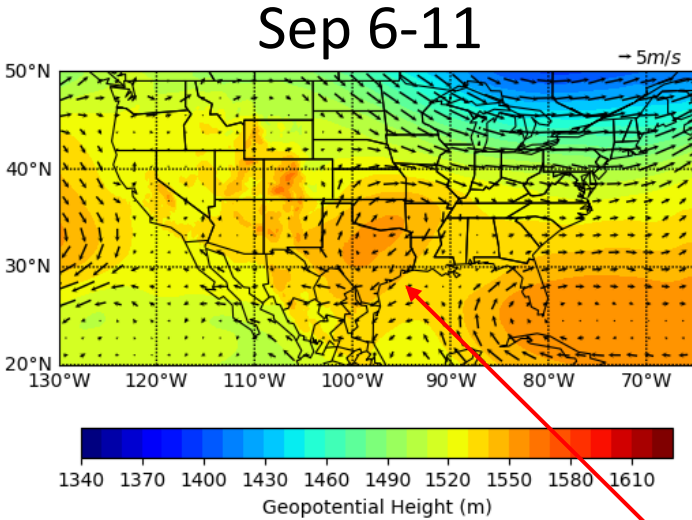
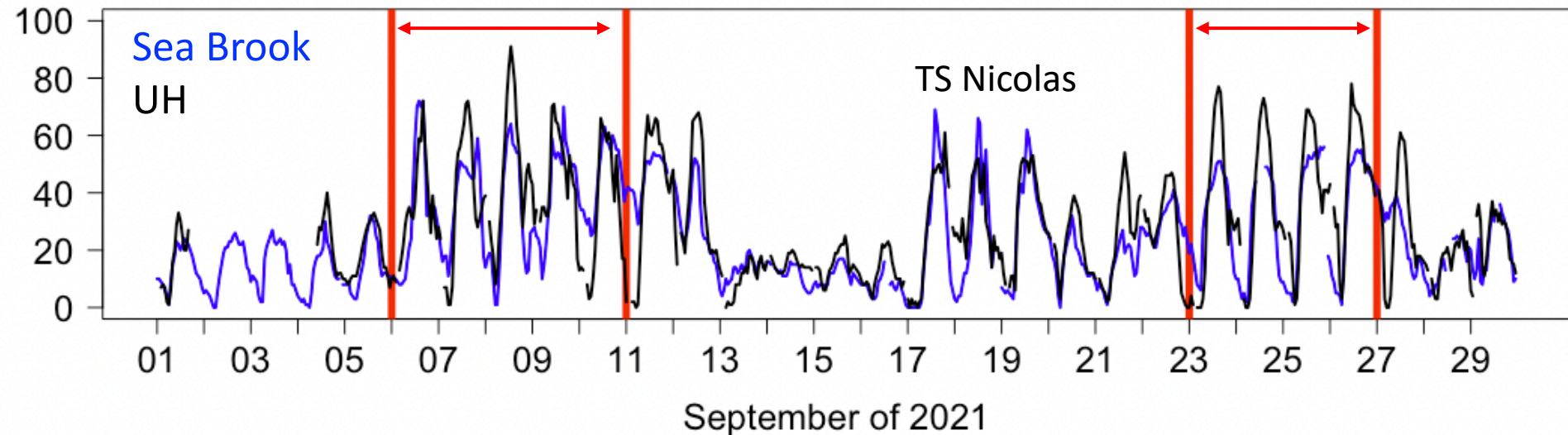

N-NE winds

S winds

WRF Model Configurations

Simulations	BC Meteorology	PBL	Microphysics	Nudging
[Base]	NCEP FNL	MYNN	2M	No
[WSM6]	NCEP FNL	MYNN	WSM6	No
[YSU]	NCEP FNL	YSU	2M	No
[ACM2]	NCEP FNL	ACM2	2M	No
[ERA5]	ECMWF ERA5	MYNN	2M	No
[SIP]	ECMWF ERA5	YSU	WSM6	No
[Nudged v1]	NCEP FNL	MYNN	2M	Yes
[Nudged v2]	NCEP FNL	MYNN	2M	Yes
[HRRR]	HRRR	MYNN	2M	No

*Nudging includes: (1) Observation nudging (v1 w/ CAMS sites; v2 w/all available observations), (2) Surface analysis nudging, (3) Objective analysis (to improve initial and boundary conditions)

**HRRR: High-Resolution Rapid Refresh meteorology at 3-km, hourly updated

[Nudged] and [HRRR] outperform other options

Compared to on-land observations

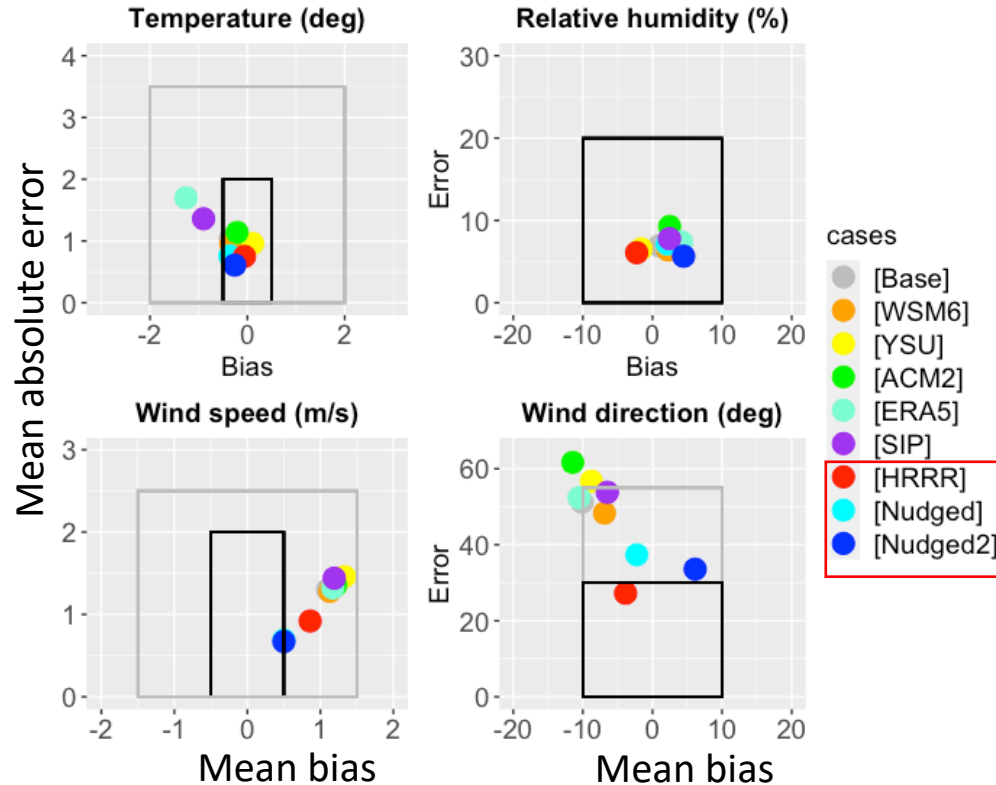

Compared to over-water observations

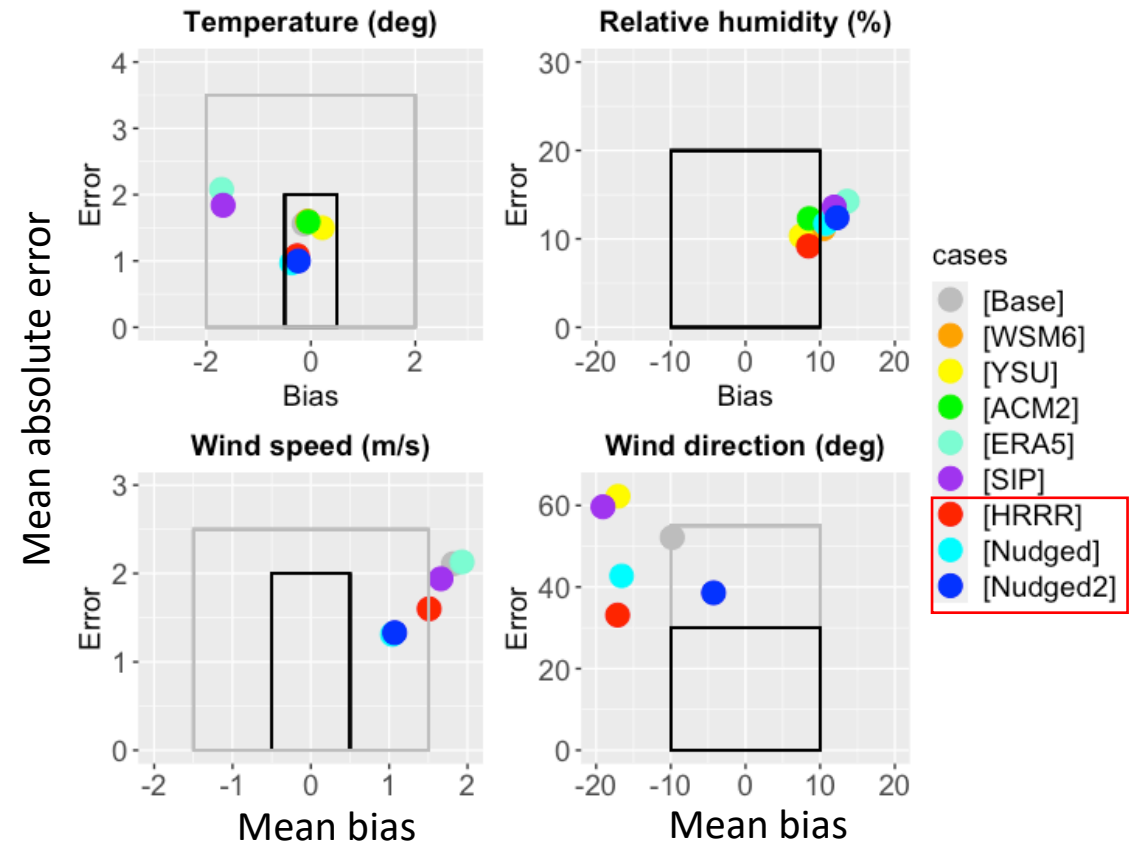

Black boxes: Simple benchmark (Emery et al., 2001)
Grey boxes: Complex benchmark (WRAP, 2013)

- Model has better performance on land
- Model overestimates wind speeds, esp. over-water
- Model actually captures wind direction changes

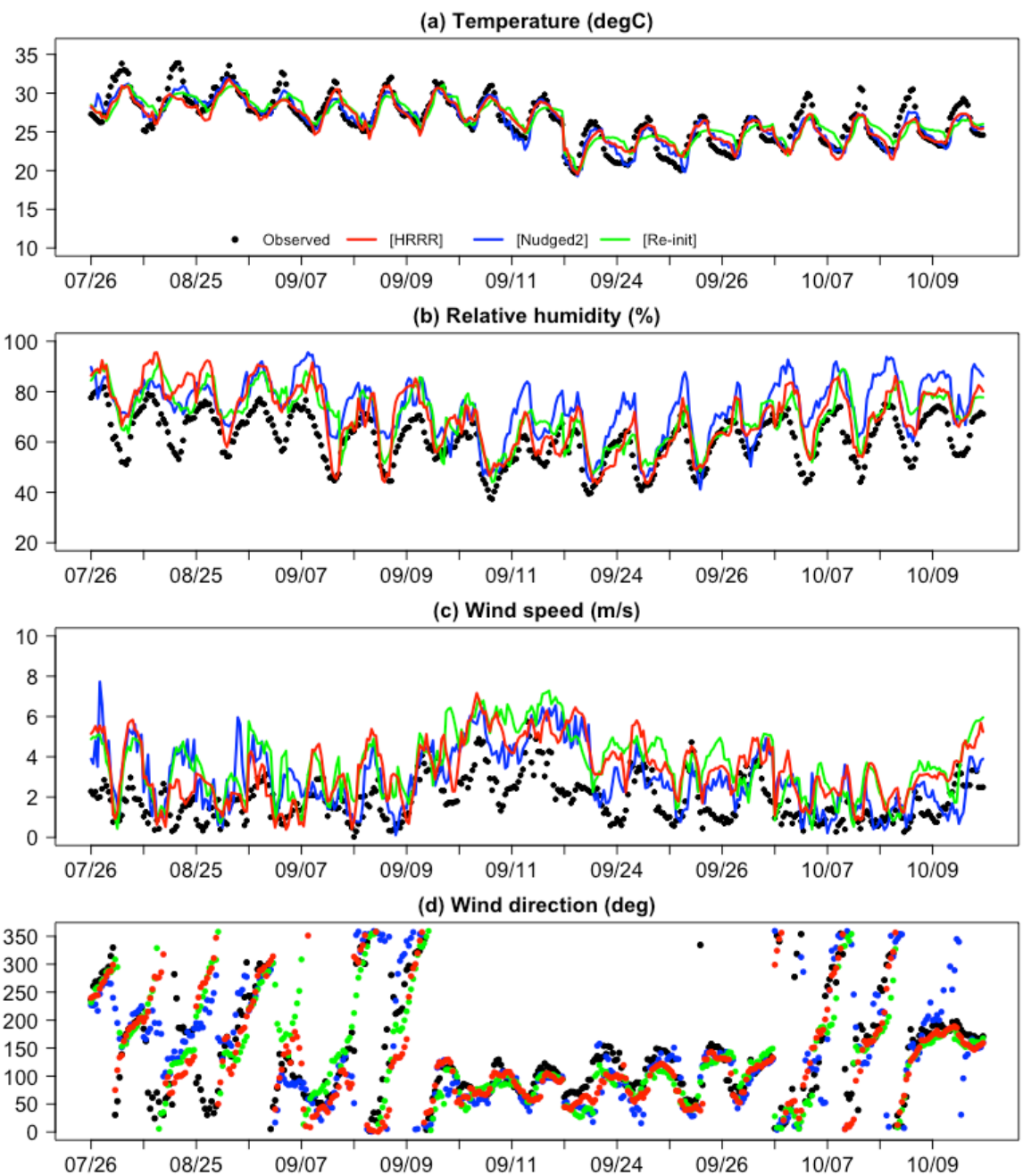

PBL Evaluation on land: La Porte

Ceilometer derived PBL at La Porte

Sep 8

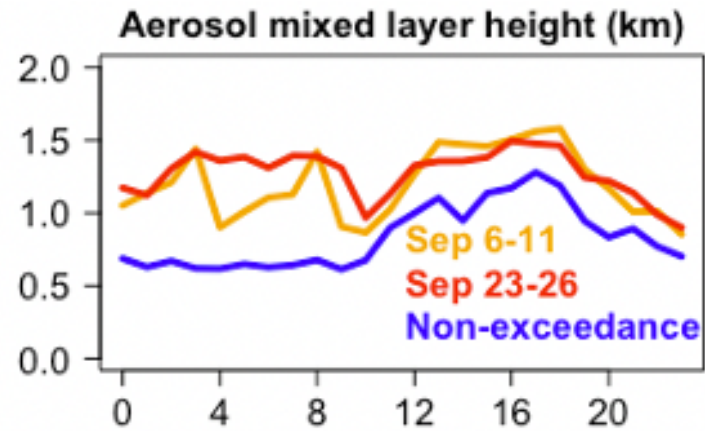
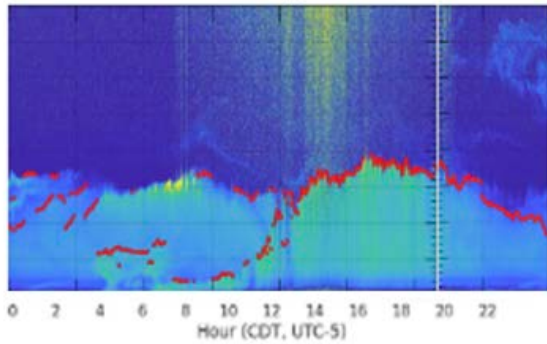

PBL Evaluation on land: La Porte

Ceilometer derived PBL at La Porte

Sep 8

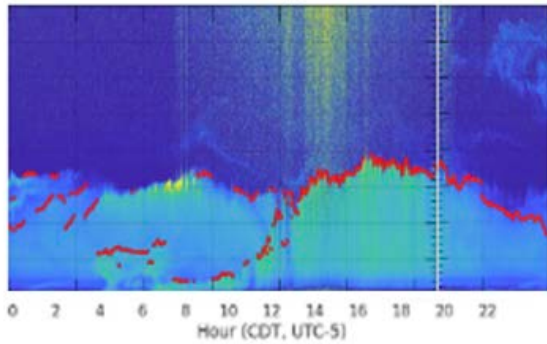

Aerosol mixed layer height (km)

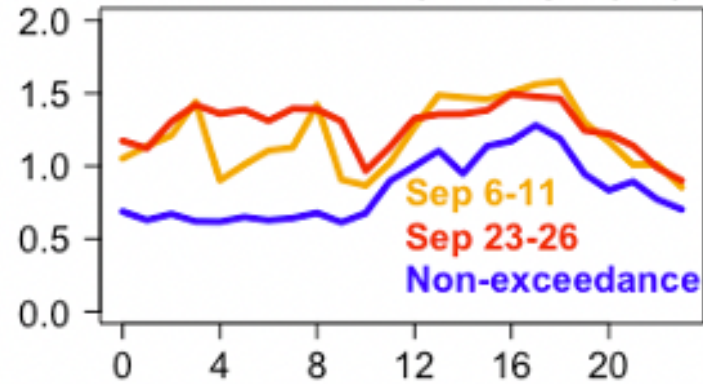

- Model reproduces PBL in the afternoon
- [HRRR] has the best PBL performance
- All configurations underestimate nighttime PBL, due to not identifying the residual layer

Non-exceedance days

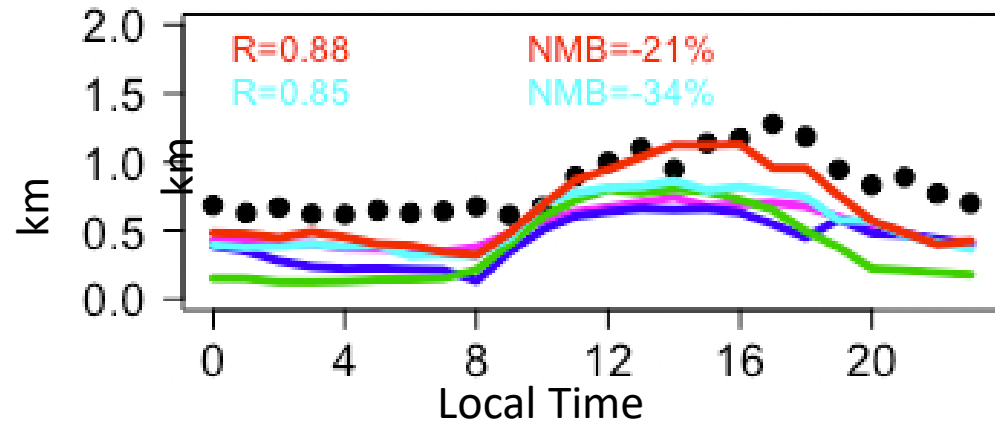

Ozone Episode days

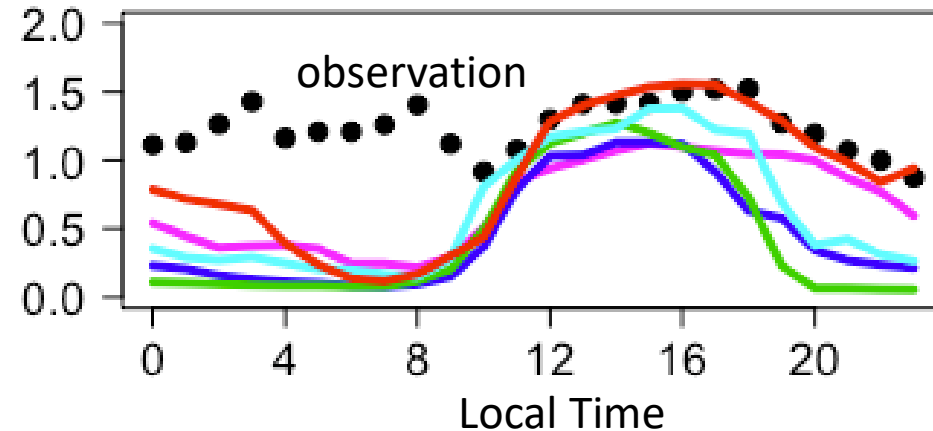

[Base]
[YSU]
[ACM2]
[HRRR]
[Nudged]

Over-water PBL Comparison

Ceilometer derived PBL on boat

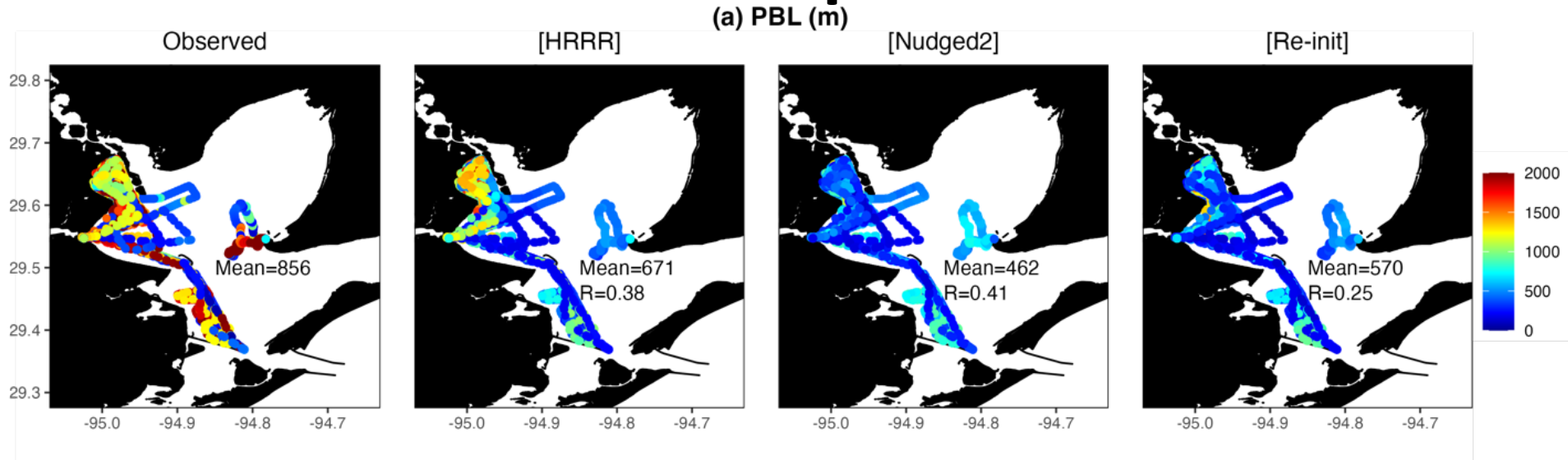

Satellite lidar derived MLH by High-Spectral-Resolution Lidar – Generation 2 (HSRL-2)

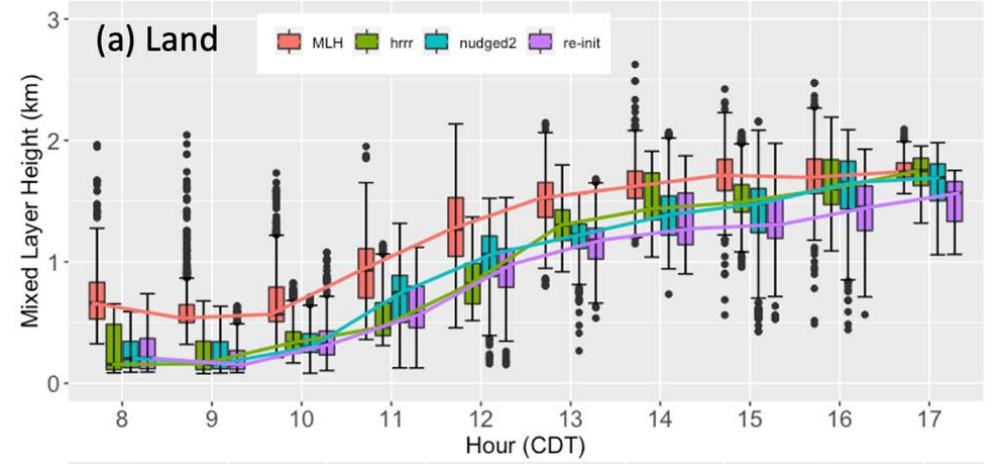
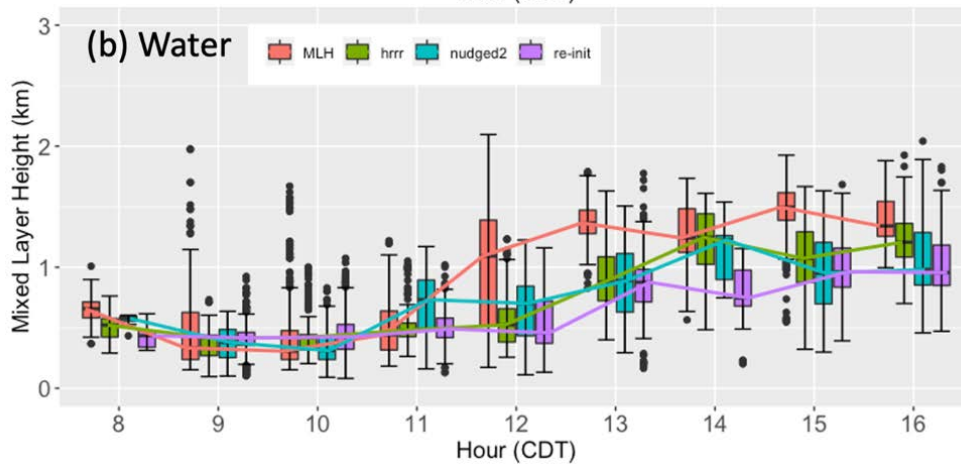

- Model underestimates marine PBL close to the coast
- Model underestimates the rapid increase of marine PBL in late morning

Summary

Q1. Which **configurations and simulation settings of WRF** most accurately replicate the extensive meteorological data collected as part of TRACER-AQ?

A: [HRRR] is the easiest and the most effective option to reproduce meteorology during the TRACER-AQ 2021 campaign. Still, WRF overestimates wind speeds and has difficulty in reproducing wind directions

Q2. How well do coupled mesoscale meteorological and photochemical grid modeling of **coastal/maritime boundary layers** replicate observations?

A: The WRF model, regardless of configuration settings, shows persistent underestimates of PBL heights on-land and over water. The model captures the low marine PBL in the morning but has difficulties capturing the high PBL in the afternoon, leading to low correlation among different configurations and a low bias.

Photochemical Model Evaluation and Intercomparison: September 2021

CAMx

domain 1

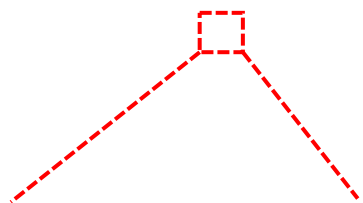

domain 2

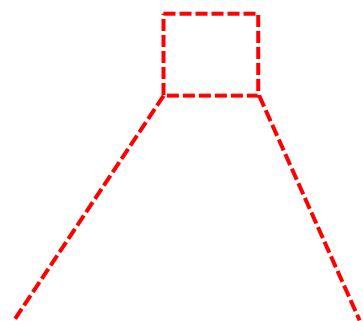

domain 3

33.6±10.5 ppb

53.0±14.7 ppb

46.9±12.8 ppb

1) All models capture high ozone mixing ratios across inland and offshore areas in southeastern Texas during Episode 1 (Sep. 6th-11th) and Episode 2 (Sep. 23rd - 26th).

Ozone (ppb)

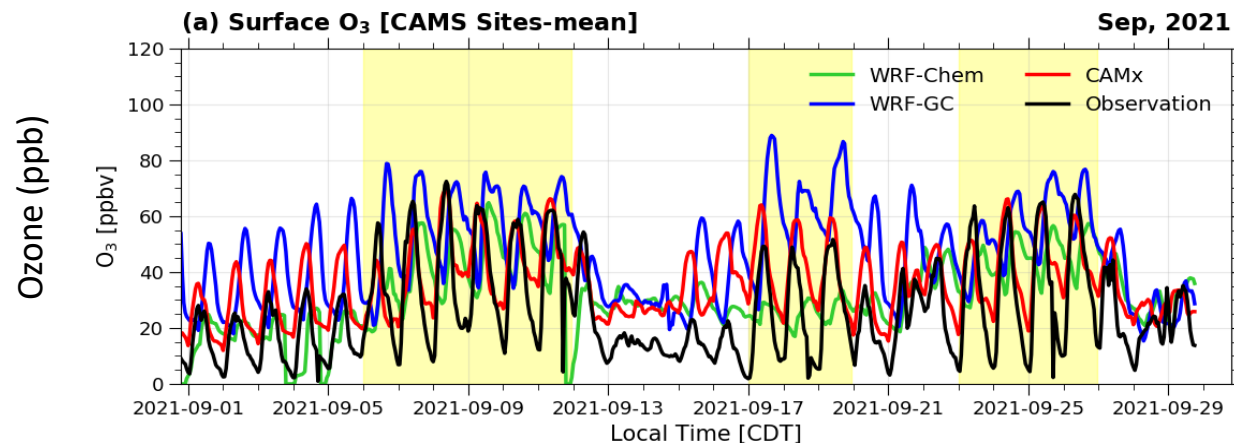

Ozone (ppb)

2) Mean state of on-land surface ozone: WRF-GC > CAMx > WRF-Chem

3) All models overestimate ozone in clean days

Over-water surface ozone prediction

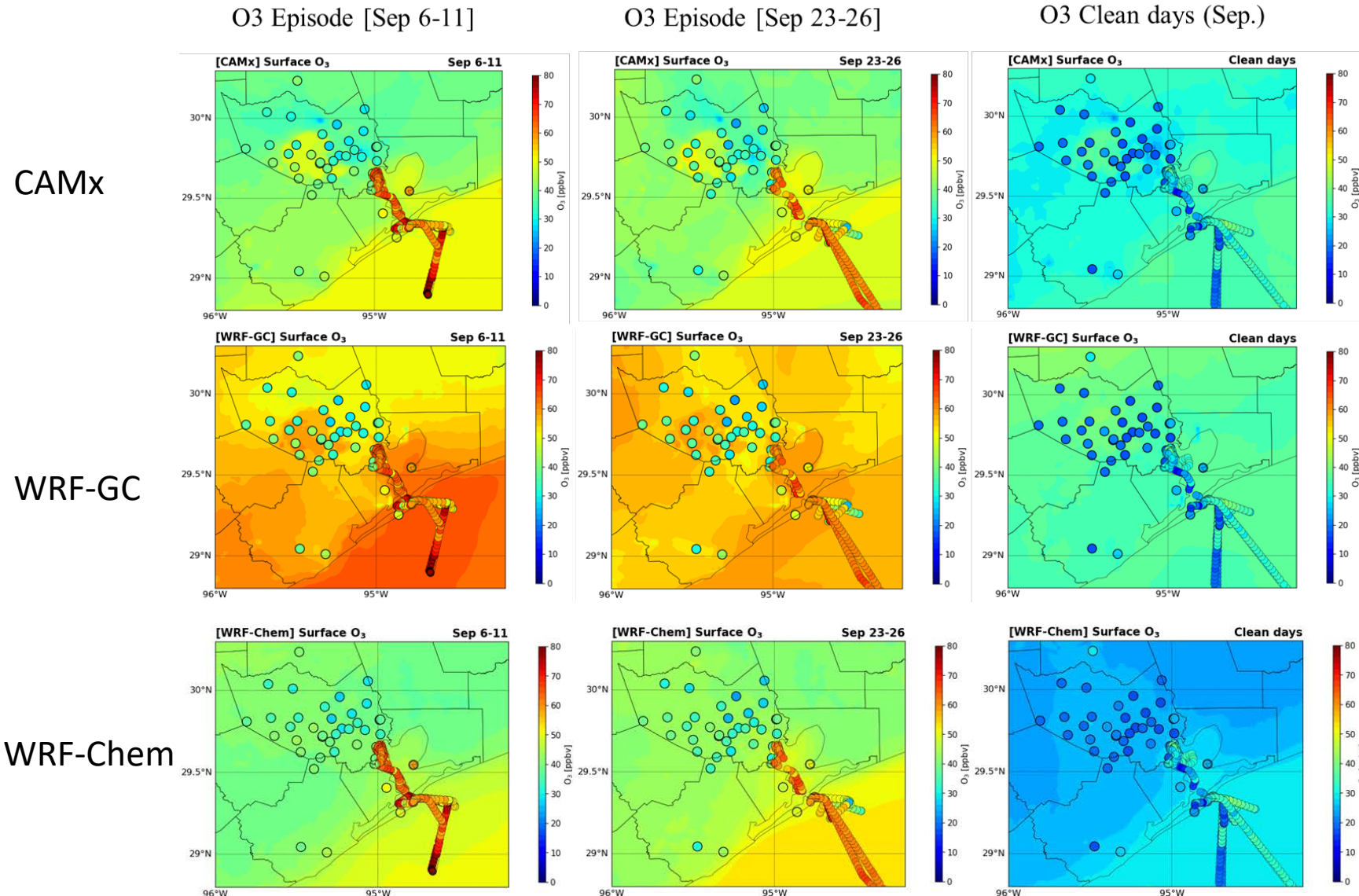

- All models underestimate offshore ozone during episode periods
- WRF-GC has the lowest bias in offshore ozone
- CAMx has the highest correlation with offshore ozone (not shown)

* To get the difference, observation points within 0.05° are considered as the same point (Offshore data).

* Some boat observations do not cover all days of identified O_3 period, which can make the plot exaggerated (Offshore data).

Model intercomparison: O₃ distribution

$$\text{O}_3 \text{ anomaly} = [\text{O}_3] - [\text{Monthly mean O}_3 \text{ for the whole domain}]$$

Observed Ozone Episode (Sep 6 – 11)

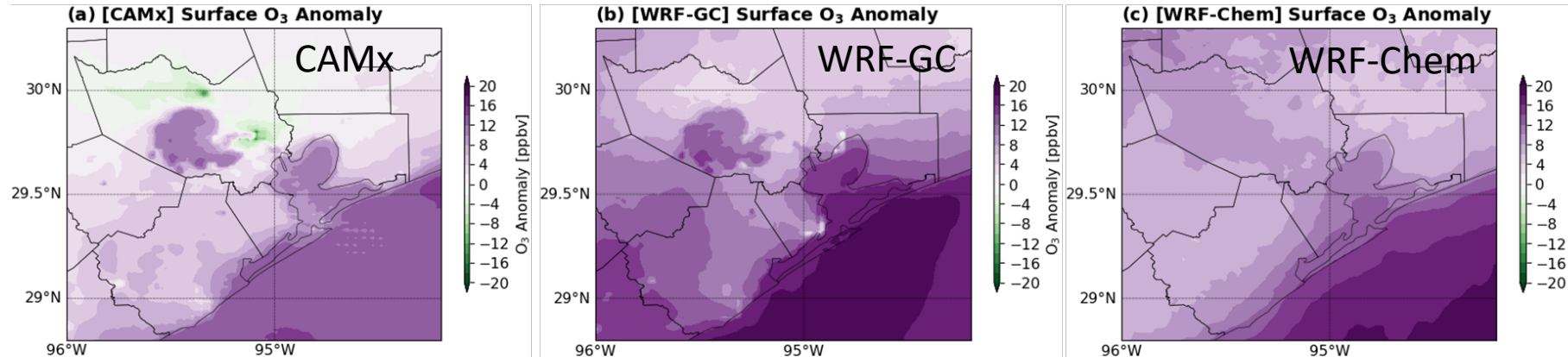

- All models predict higher ozone offshore than on land during episode periods
- WRF-GC predicts largest enhancement in offshore ozone during exceedance days

Observed Ozone Episode (Sep 23 – 26)

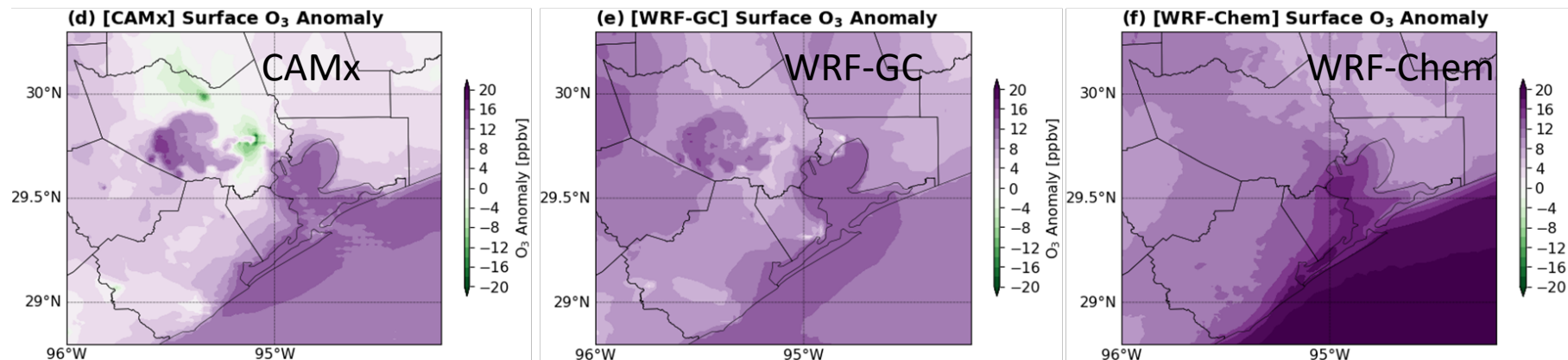

O₃ distribution compared to observations

* O₃ Difference: Two O₃ Episodes [Sep 6-11 & 23-26] – Clean days (Dots: On/offshore observation)

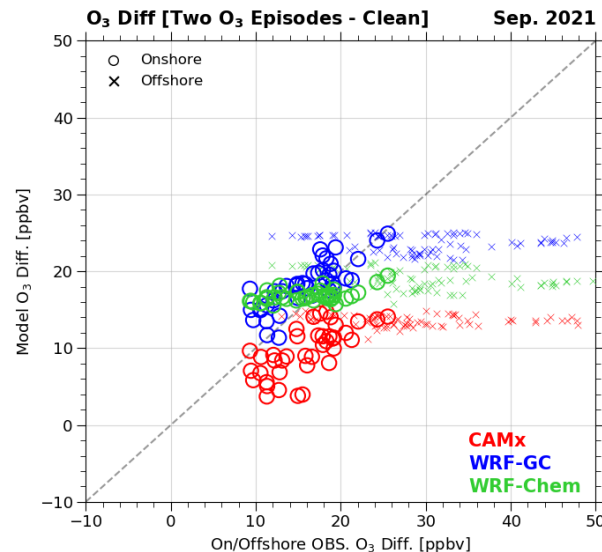
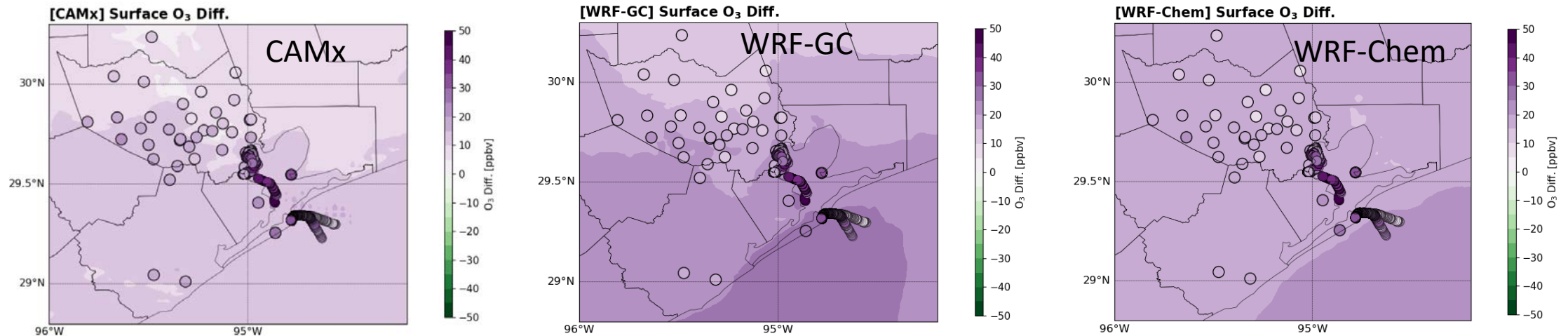

- All models underestimate offshore ozone enhancements during episode periods
- CAMx has the largest underestimate
- WRF-GC has the best performance in simulating ozone enhancements for both on-land and offshore locations

Vertical Distribution of O₃

TOLNet lidar at UH (left) and La Porte (right), Sep 6-11

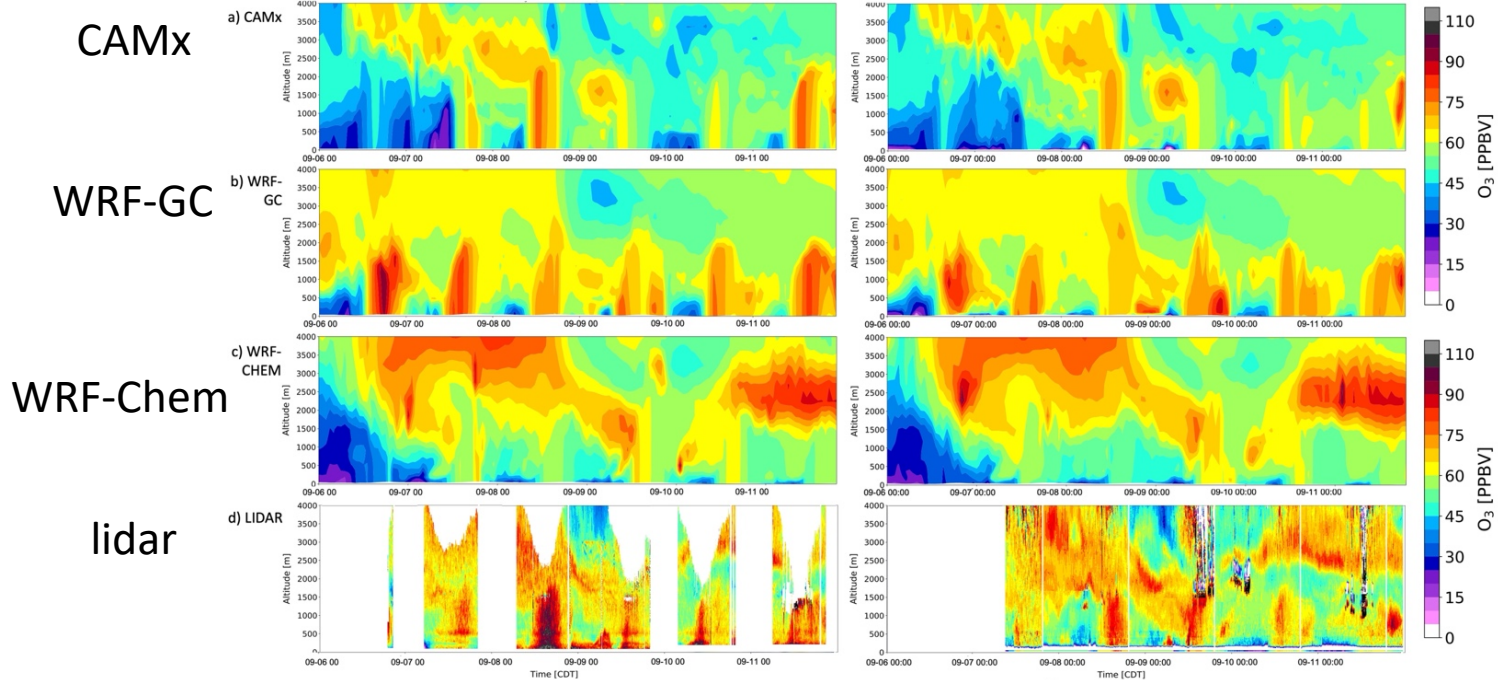

Offshore Ozonesonde
Galveston Bay

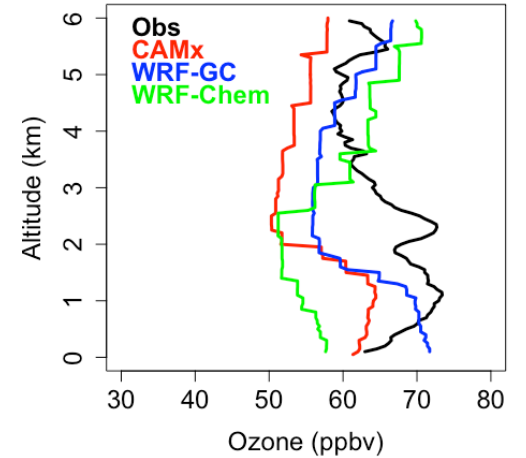

Gulf of Mexico

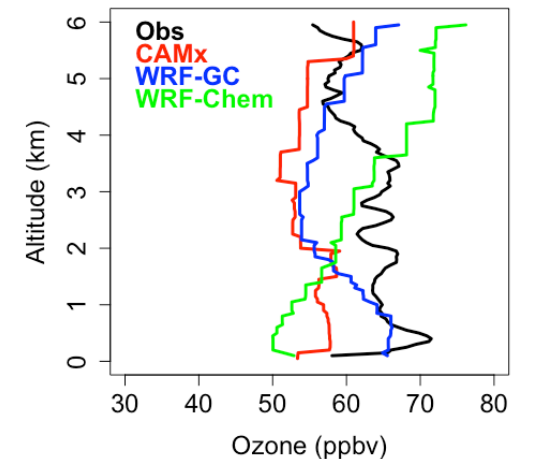

HSRL-2
derived
0-1km
ozone

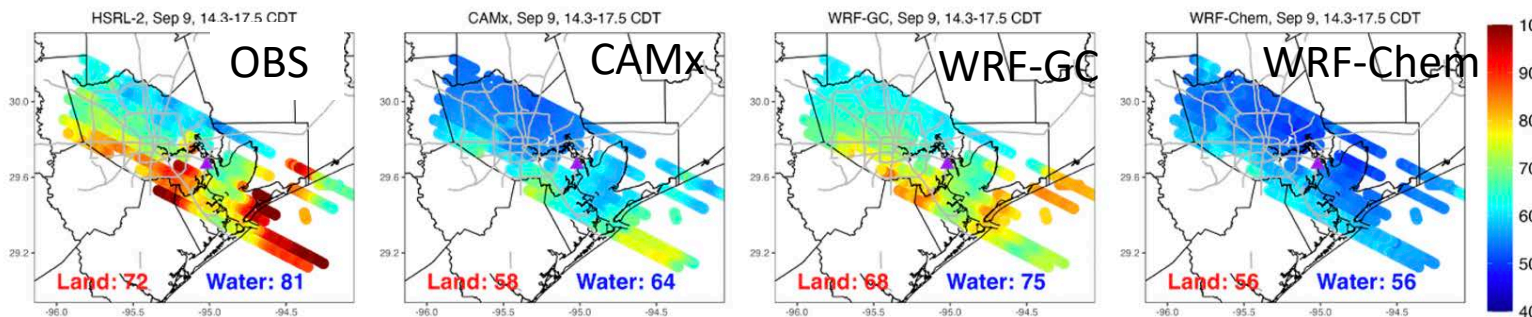

- WRF-Chem best captures free troposphere (3-4 km) ozone plume
- WRF-GC best matches with 0-1 km ozone and residual layer ozone (1-2 km)

	CAMx	WRF-GC	WRF-Chem
Meteorological IC/BC	HRRR	HRRR	HRRR
Chemical IC/BC	GEOS-Chem (2021)	GEOS-Chem (2021)	WACCM (2021)
Gas-phase chemistry	CB6r5	Full O _x -NO _x -VOC-halogen-aerosol chemistry in GEOS-Chem	MOZART
Aerosol chemistry	N/A		MOSAIC
Anthropogenic emission	TCEQ SIP (2019)	TCEQ SIP (2019)	TCEQ SIP (2019)
Fire emission	FINNv1.5 (2019)	GFED (2019)	FINNv2.5 (2021)
Soil NO _x	BEIS version5 (2019)	Hudman et al., 2012 (online calculation)	MEGAN (online calculation)
Lightning NO _x	N/A	Murray et al., 2012 (online calculation)	N/A
Biogenic	BEIS version5 (2019)	MEGAN (online calculation)	MEGAN (online calculation)

Summary

Q3. How well do **photochemical grid models predict over-water ozone concentrations and formation rates?**

A: All models underestimate offshore ozone during episode periods, despite being able to simulate higher offshore ozone compared to clean conditions. WRF-GC has the lowest bias, while CAMx has the highest correlation with offshore ozone. WRF-Chem is best at capturing free-troposphere ozone plumes.

Q4. What are the **spatial distributions of ozone and ozone precursors** during TRACER-AQ on days with on-land monitors recording exceedances of the NAAQS and how well does the photochemical model predict such distributions?

A: High ozone is found in southwest Houston, the Ship Channel, and offshore. CAMx has the best performance for on-land distributions, while WRF-GC is best at offshore distributions. WRF-Chem does not capture high ozone in southwest Houston

CAMx Process Analysis

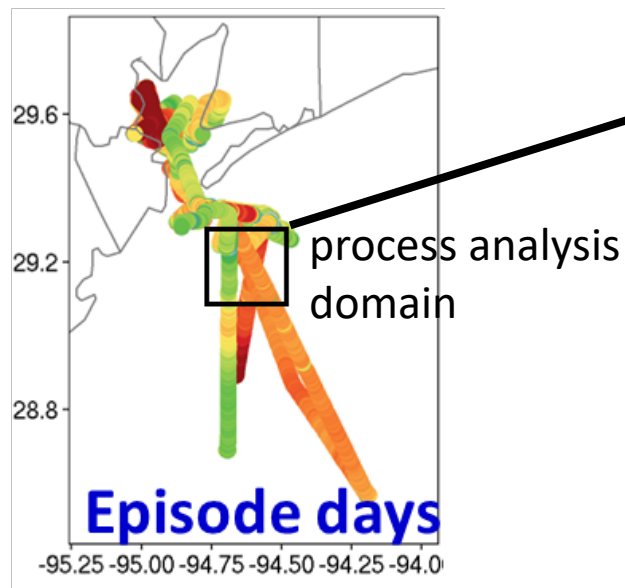

(a) Diurnal changes of simulated ozone process on clean days (stripes) and ozone-episode days (bars).

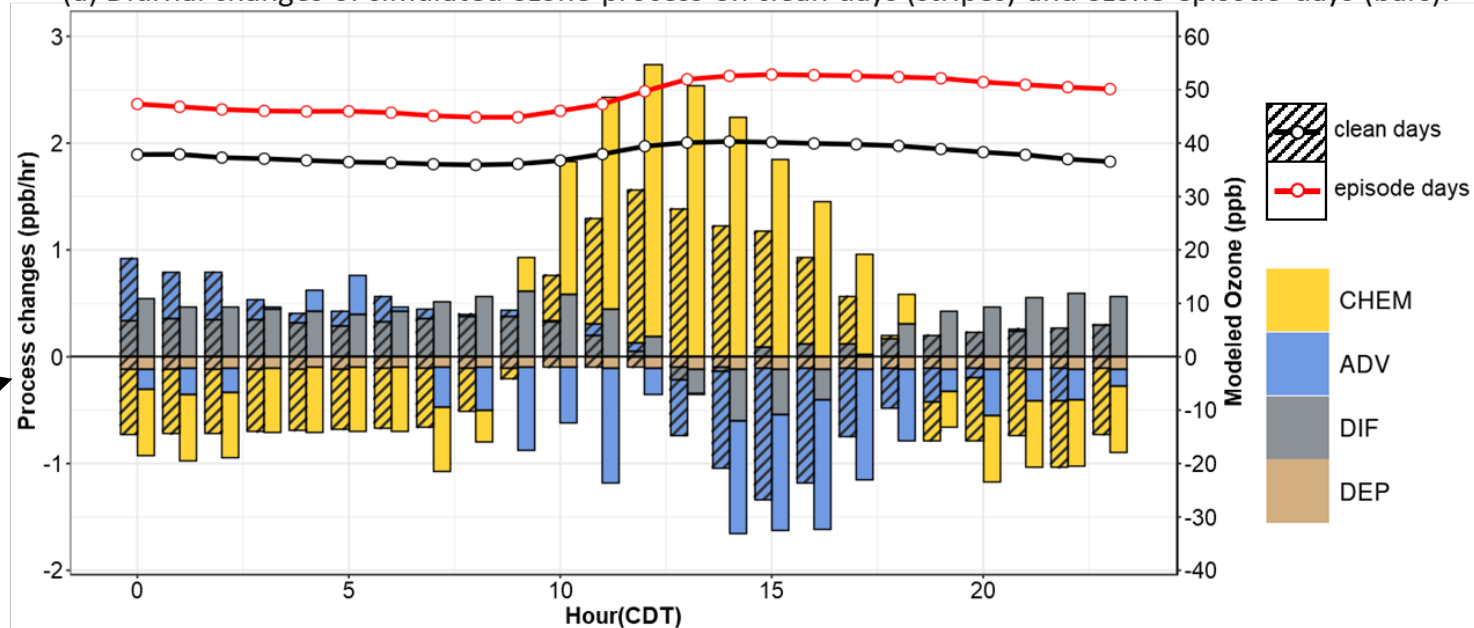

(b) Simulated ozone process changes on ozone-episode days from clean days.

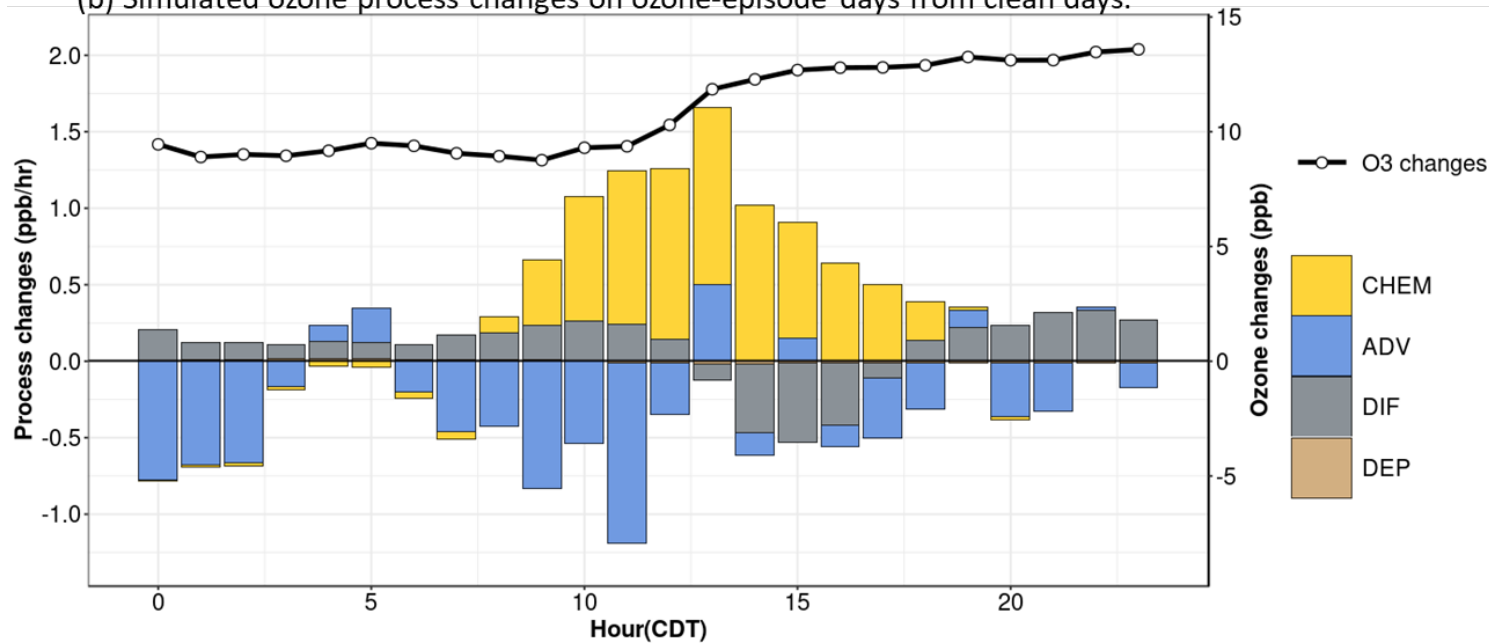

On average:

- Sink: ADV and DEP.
- Source: DIF and CHEM
- CHEM increases the most on episode days followed by DIF.

Sources of elevated offshore ozone

- Anthropogenic emissions from outside Houston
 - Houston background: quantified via zeroing anthropogenic emissions in the innermost (d03) domain (1.33km-resolution)
- Houston anthropogenic emissions: on-land and offshore
 - Soft emission perturbation experiments (10% reduction in NO_x or VOC)

	Land NO _x	Land VOC	Water NO _x	Water VOC
[CTR]	Full	Full	Full	Full
[BGD]	Zero	Zero	Zero	Zero
[Land_NO _x]	10% reduction	Full	Full	Full
[Land_VOC]	Full	10% reduction	Full	Full
[Water_NO _x]	Full	Full	10% reduction	Full
[Water_VOC]	Full	Full	Full	10% reduction

Large Houston background predicted by models

CAMx

WRF-GC

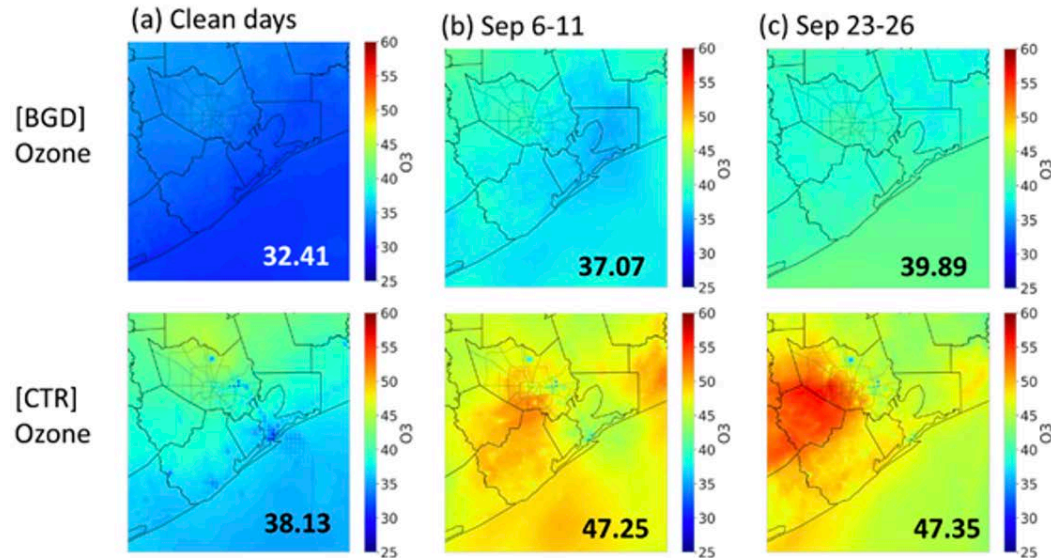

- Regional background is 78-85% of total ozone
- Regional background increases by 7-10 ppbv during episode days, while total ozone increases 9-10 ppbv

- Regional background is 86-88% of total ozone
- Regional background increases by 14-17 ppbv during episode days, while total ozone increases 17-19 ppbv

Model intercomparison on ozone precursors: NO_x

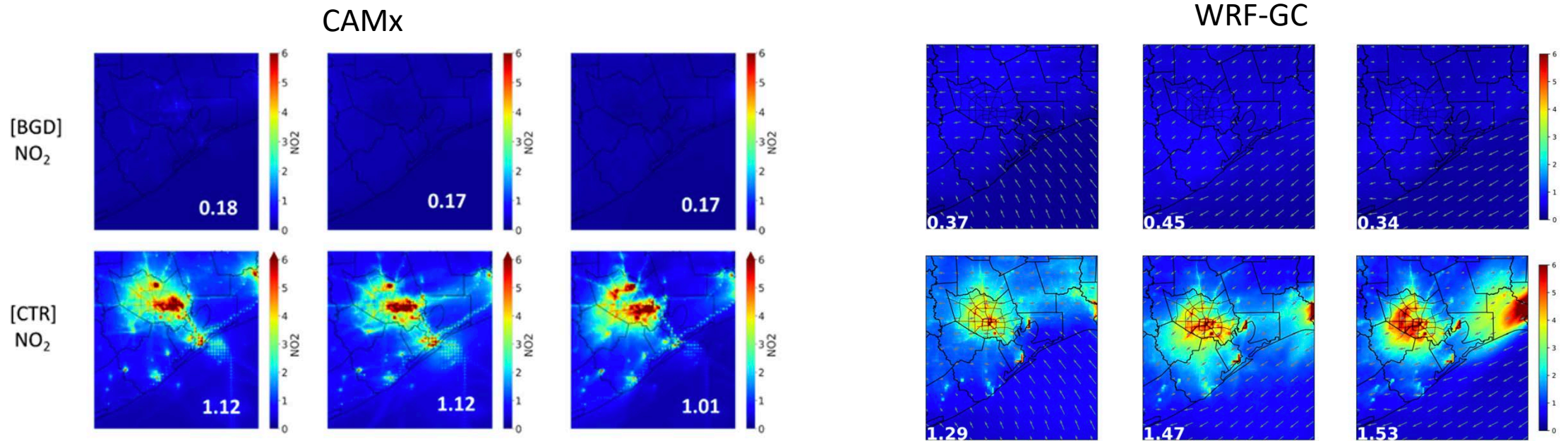

- NO_x concentrations are similar in [CTR] between CAMx and WRF-GC
- NO_x concentrations in [BGD] are a factor of two higher in WRF-GC, due to natural NO_x emissions

Model intercomparison on ozone precursors: isoprene

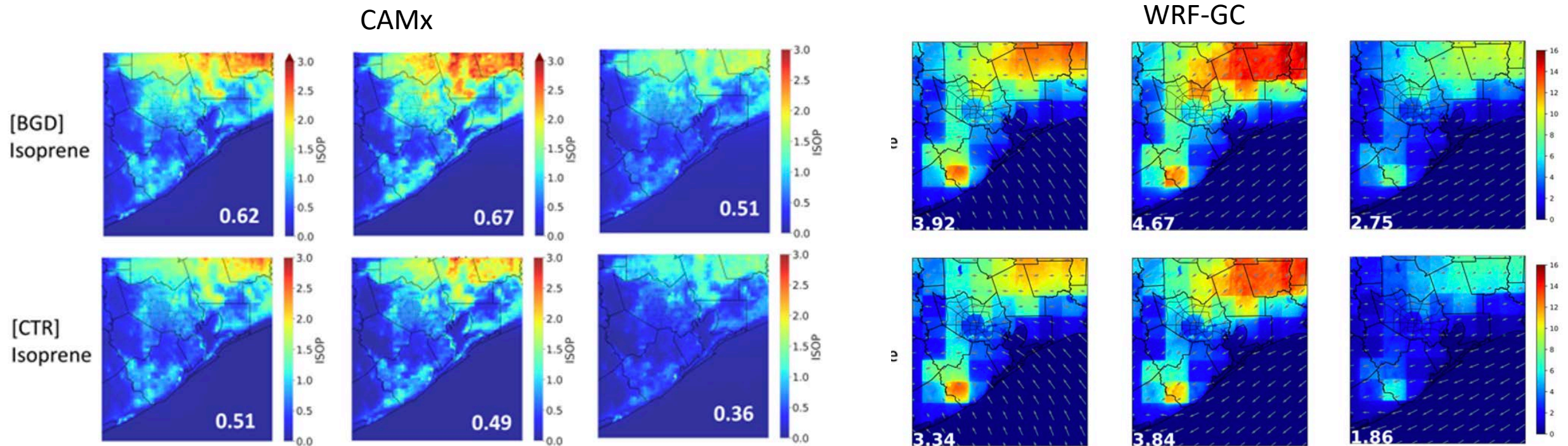

- Isoprene concentrations differ by a factor of 6 between CAMx and WRF-GC
- Isoprene concentrations do not change much between clean and episode days
- Isoprene concentration increases in [BGD] simulation due to reduced oxidants

Model intercomparison on ozone precursors: HCHO

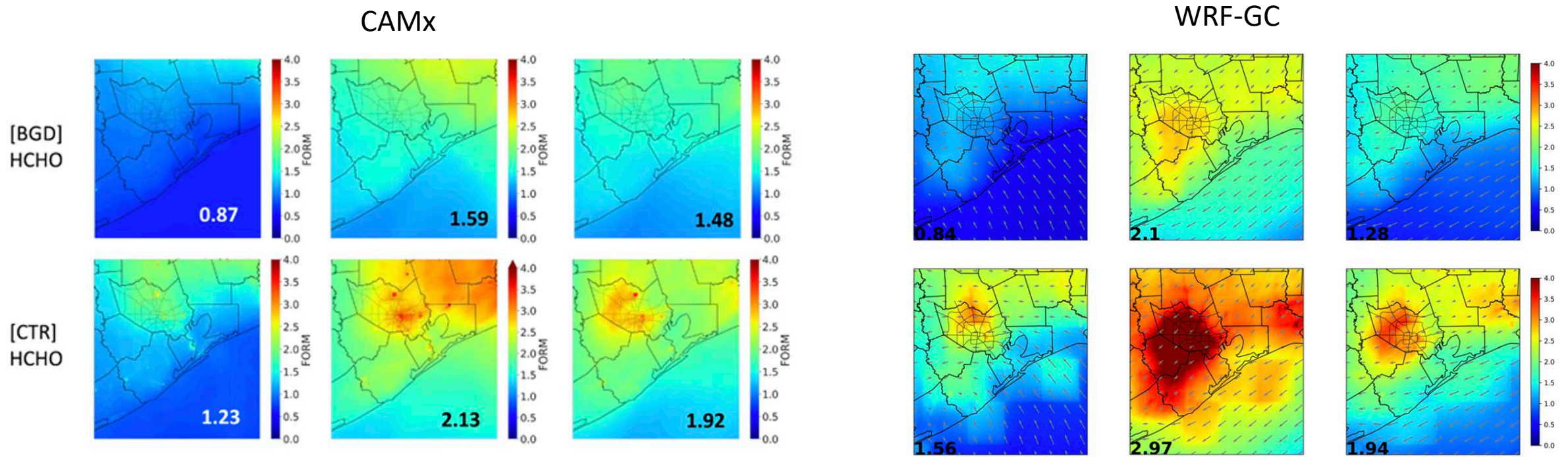

- HCHO concentrations differ by 30% between CAMx and WRF-GC
- Houston background accounts for 73-75% of total HCHO predicted by both models (natural emissions and/or transport)
- 70-90% increases in HCHO in [BGD] simulations between clean and episode days (regional transport of VOCs from outside Houston)

Model intercomparison on ozone precursors: HCHO

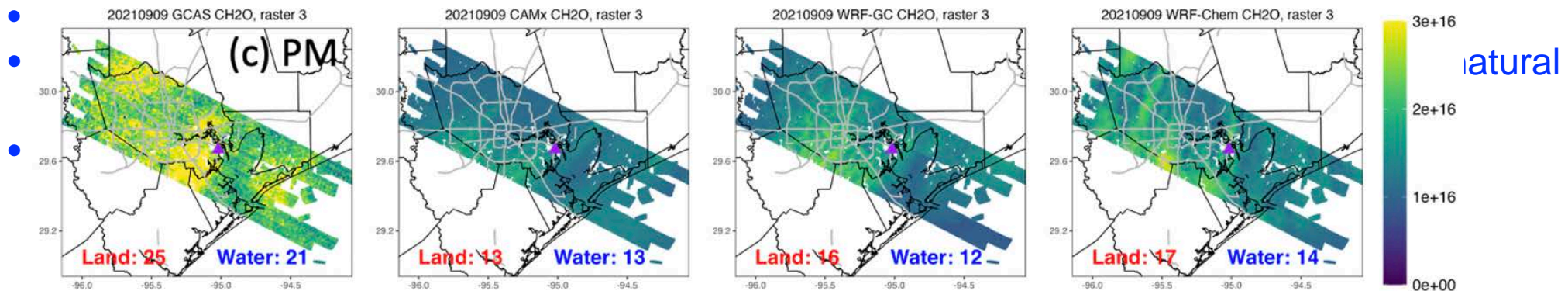
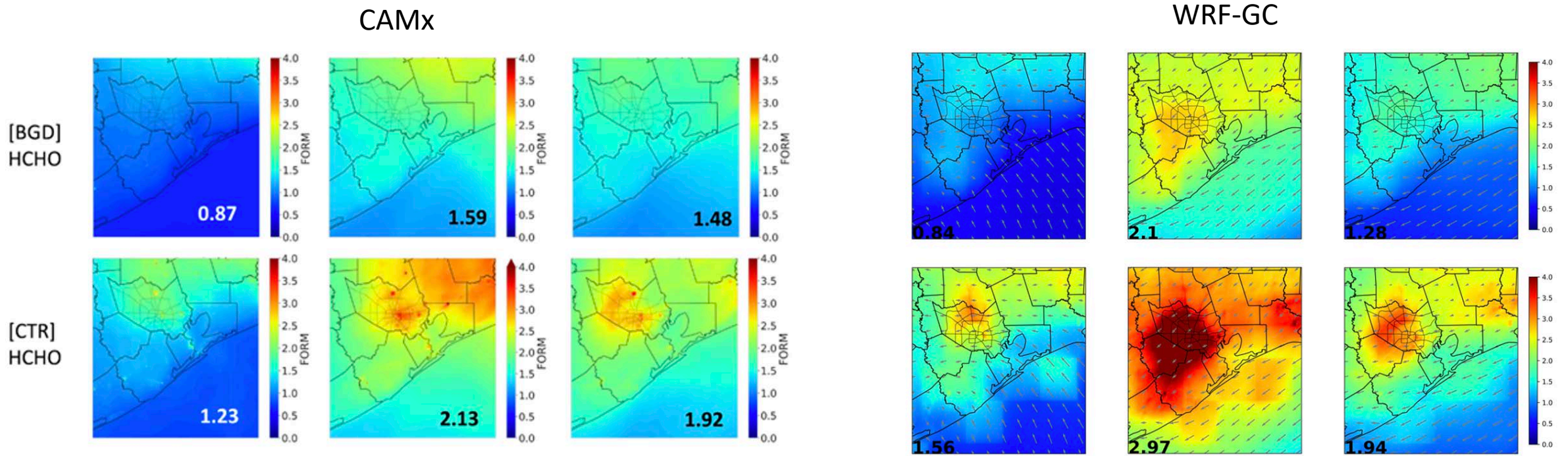

Emission Perturbation Experiments

(a) Percentage changes during Sep 6-11: $\frac{([Land_NOx] - [CTR])}{[CTR]} * 100$

CAMx
[Land_NOx]

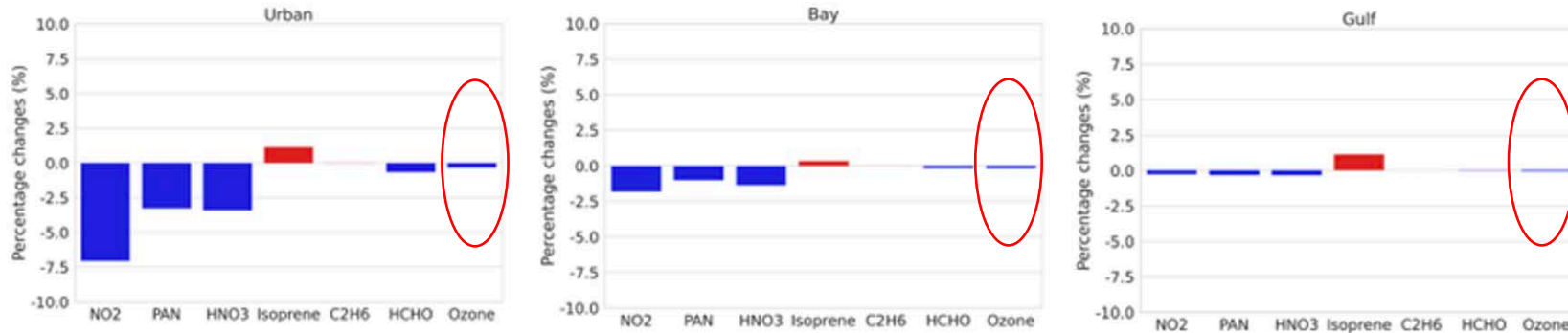

WRF-GC
[Land_NOx]

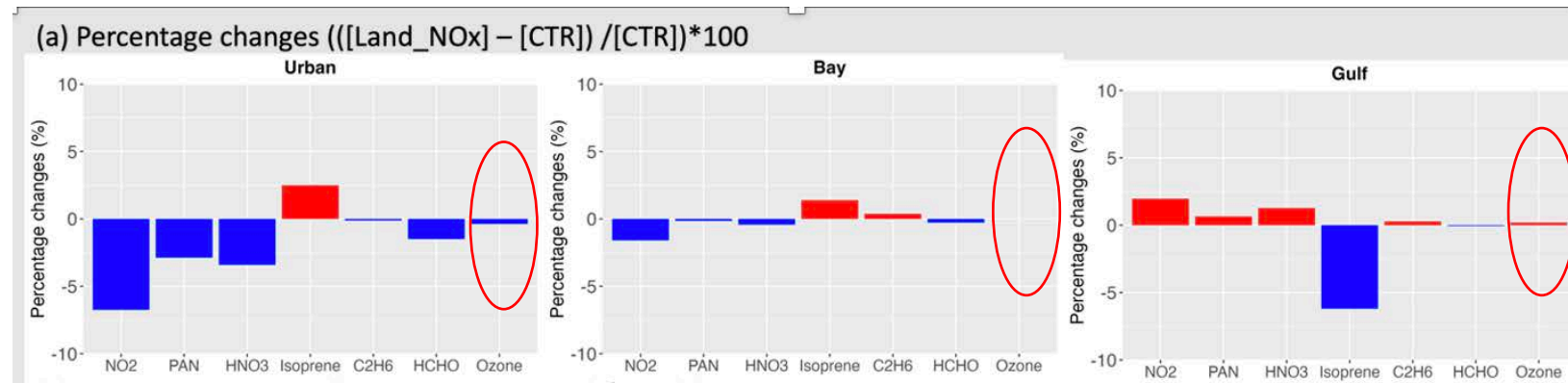

- Less than 1% change in ozone in all emission perturbation experiments, consistent with high Houston background in both models
- Offshore ozone in models is not sensitive to local emissions, harder to control

Summary

Q5. Which **emission source categories** affect ozone formation over Galveston Bay and the Gulf of Mexico?

A: We found the largest contribution to offshore ozone comes from regional background (e.g., natural emissions, anthropogenic emissions from outside Houston). Local anthropogenic emissions contribute to less than 20% of surface ozone over Galveston Bay and the Gulf of Mexico during the episode periods. Ozone precursors originating from outside Houston, particularly VOCs, are likely the main contributor to in situ ozone production at offshore locations. This finding reveals the resiliency of high ozone over water to small changes in land emissions or over-water emissions, making it difficult to control.

Suggestions on Future Work

- To improve offshore ozone prediction
 - (1) Model underestimates PBL → underestimate entrainment of local pollution from sea-breeze return flow
 - (2) Model overestimates wind speeds → too diffusive
 - (3) Halogen chemistry
- Meteorological model
 - Improvement on wind simulations and marine PBL
- Photochemical model
 - Background concentrations in models need to be evaluated and constrained
 - All models overestimate surface ozone during clean conditions, suggesting background probably too high

Extras

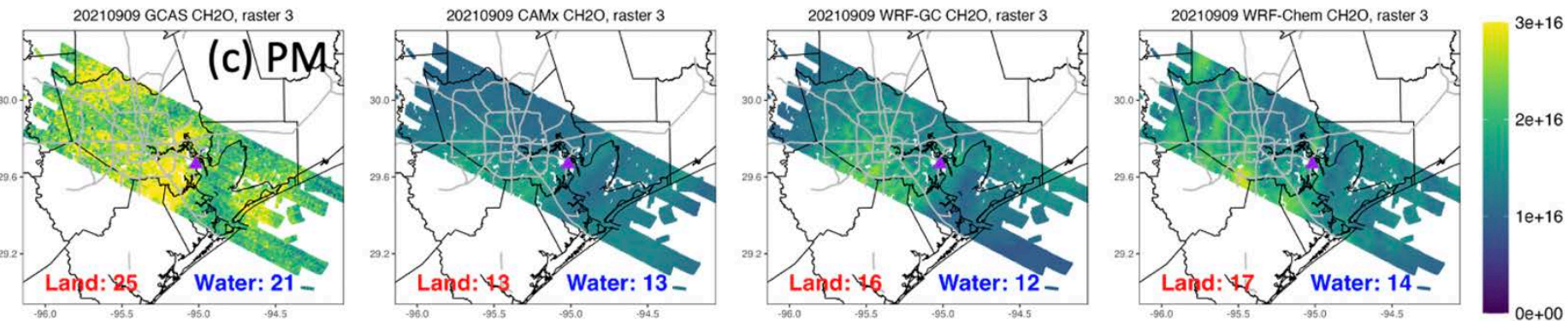
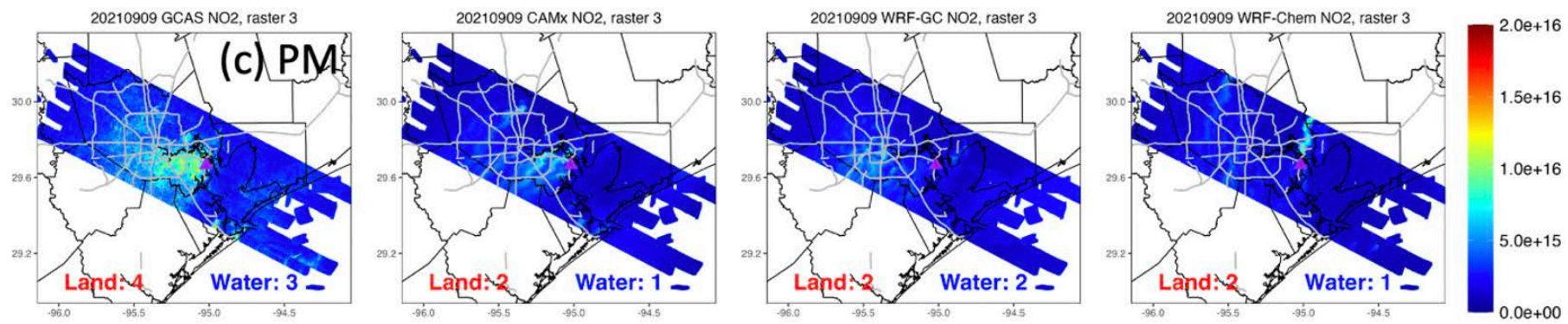
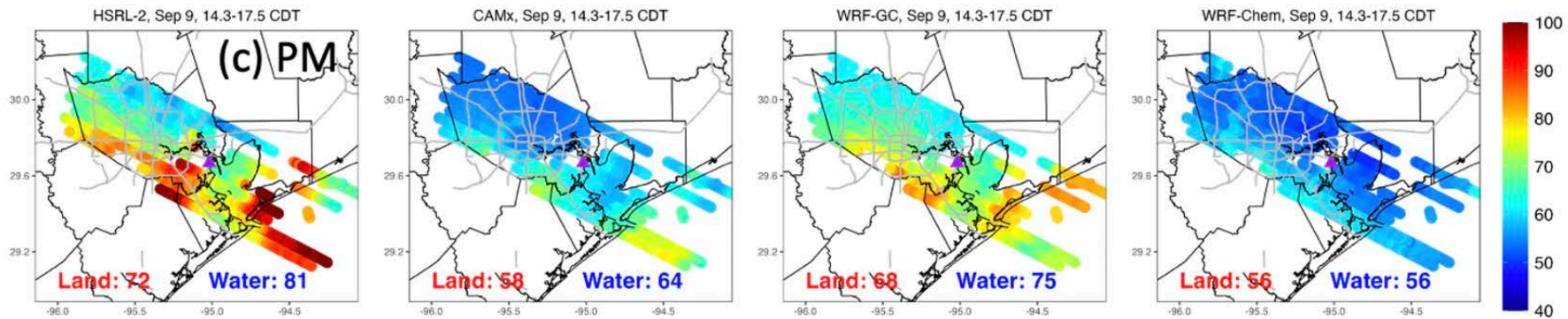

Regional transport

12 km x 12 km HYSPLIT
back trajectories

→ Episode days belong to Cluster
4 and 6

Local transport: 1.3 km x 1.3 km HYSPLIT back trajectories

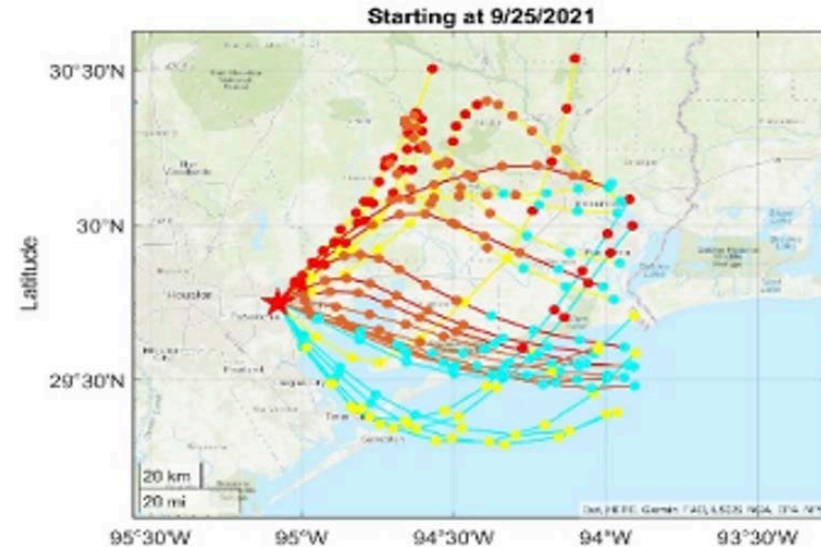

Performance metrics for winds

$$M - O = \begin{cases} M - O, & \text{when } |M - O| < 180^\circ \\ (M - O) \left(1 - \frac{360}{|M - O|}\right), & \text{when } |M - O| > 180^\circ \end{cases}$$

$$\text{Corr. } R = \frac{\sum_{i=1}^N \sin(M_i - \bar{M}) \sin(O_i - \bar{O})}{\sqrt{\sum_{i=1}^N \sin^2(M_i - \bar{M})} \sqrt{\sum_{i=1}^N \sin^2(O_i - \bar{O})}}$$

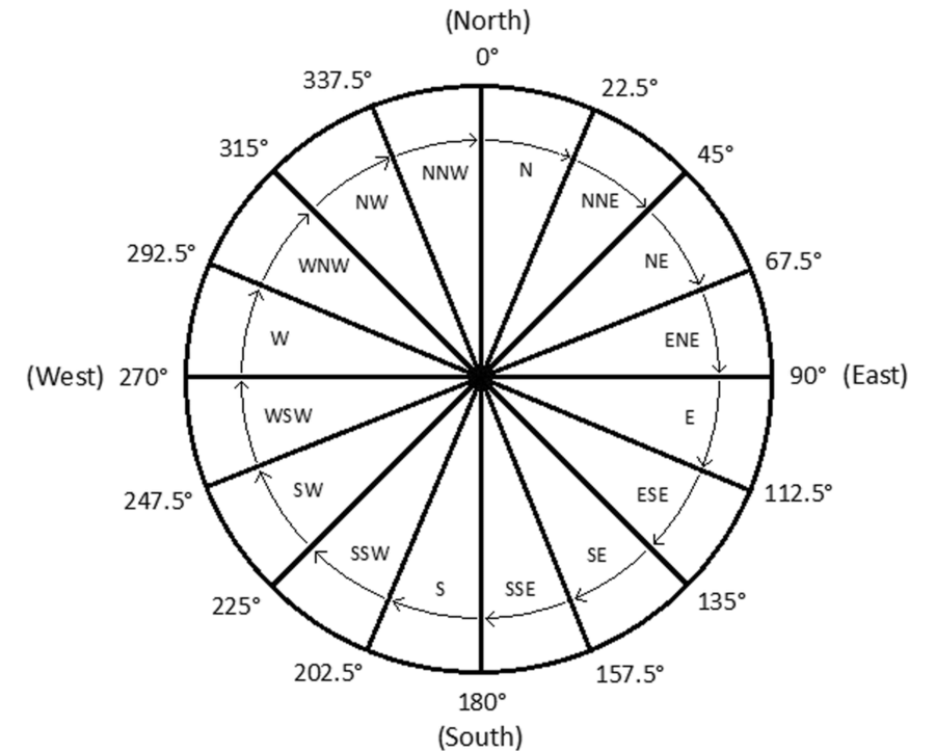

PBL Evaluation: La Porte

Sep 8

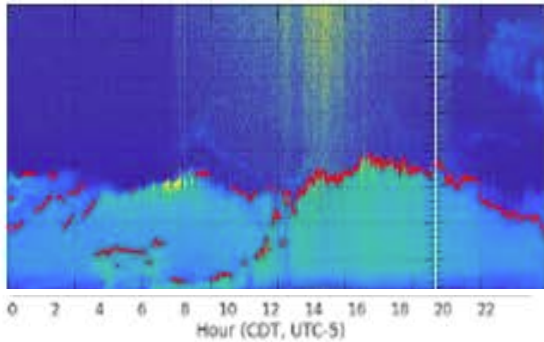

Sep 9

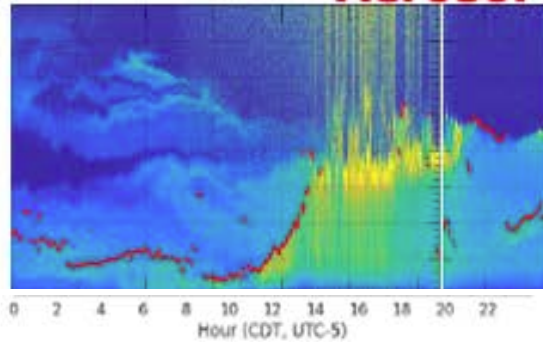

Aerosol backscatter

Sep 10

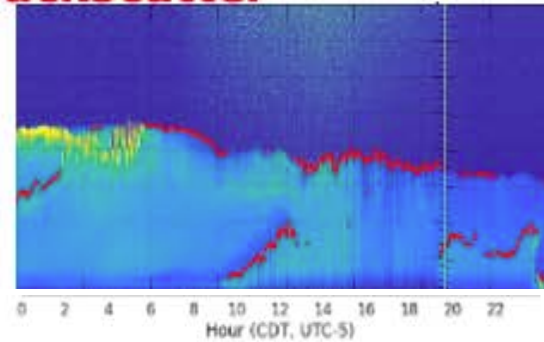

Sep 11

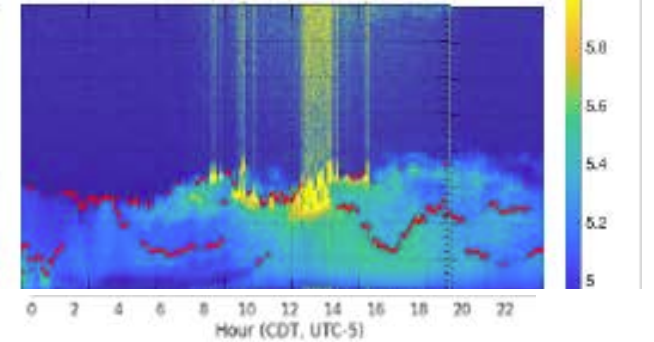

Simulated Potential Temperature Gradient

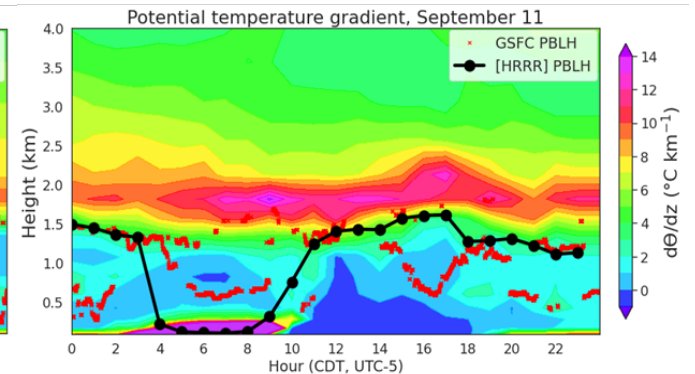
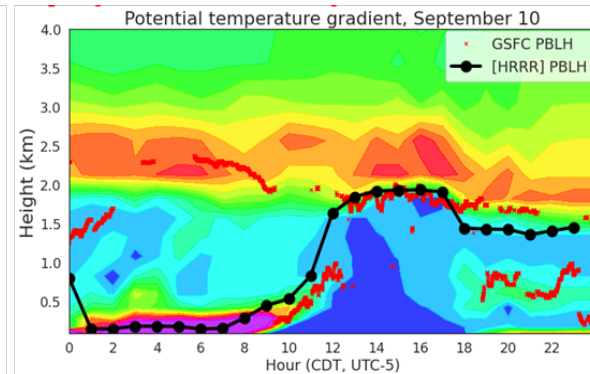
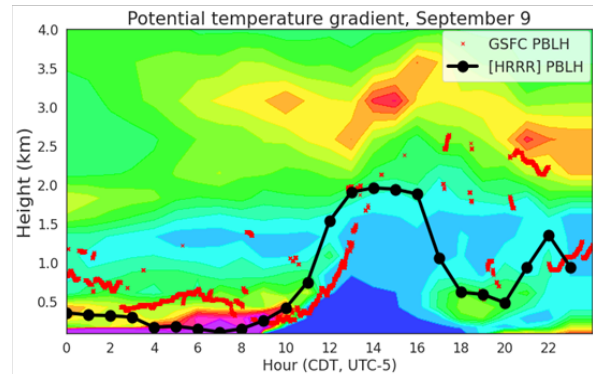
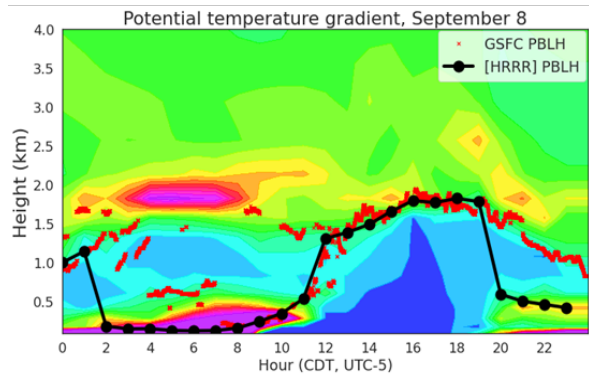

- Model is able to reproduce the vertical structure of the lower atmosphere.
- Model correctly diagnoses PBL in the afternoon
- Model puts nighttime PBL at the surface layer, but ceilometer has two layers

Table 2. Model performance metrics used in this study.

Performance Metrics	Formulas
Mean Bias (MB)	$MB = 1/N \sum_{i=1}^N (M_i - O_i)$
Mean Absolute Error (MAE)	$MAE = 1/N \sum_{i=1}^N M_i - O_i $
Normalized Mean Bias (NMB)	$NMB = \frac{\sum_{i=1}^N (M_i - O_i)}{\sum_{i=1}^N O_i} \times 100\%$
Correlation Coefficient (R)	$Corr.R = \frac{\sum_{i=1}^N (M_i - \bar{M})(O_i - \bar{O})}{\sqrt{\sum_{i=1}^N (M_i - \bar{M})^2} \sqrt{\sum_{i=1}^N (O_i - \bar{O})^2}}$
Root Mean Square Error (RMSE)	$RMSE = \sqrt{1/N \sum_{i=1}^N (M_i - O_i)^2}$

Note: M is the model output, O is the observation, N is the number of samples, and

$$\bar{M} = 1/N \sum_{i=1}^N M_i, \bar{O} = 1/N \sum_{i=1}^N O_i.$$

Wind Directions:

$$M - O = \begin{cases} M - O, & \text{when } |M - O| < 180^\circ \\ (M - O) \left(1 - \frac{360}{|M - O|}\right), & \text{when } |M - O| > 180^\circ \end{cases}$$

$$Corr.R = \frac{\sum_{i=1}^N \sin(M_i - \bar{M}) \sin(O_i - \bar{O})}{\sqrt{\sum_{i=1}^N \sin^2(M_i - \bar{M})} \sqrt{\sum_{i=1}^N \sin^2(O_i - \bar{O})}}$$